



# LONGO

ACTIU

# LONGO

- LOUNGE SEATING -

  
[www.actiu.com/longo](http://www.actiu.com/longo)



WE ARE ALWAYS ON THE MOVE, AND YOU?



## LONGO RAMOS&BASSOLS

Longo is a system capable of taking your work level to the desired point that it fuses soft seating with the office using a platform from a robust structure but with a light aspect, which acts as a link to connect and branch numerous modules in a space.

Longo es un sistema capaz de llevar tu nivel de trabajo al punto deseado, que fusiona el soft seating con la oficina mediante una plataforma de estructura robusta y aspecto ligero, que actúa de enlace para conectar y ramificar multitud de módulos en un espacio.

Longo est un système capable de d'améliorer votre productivité qui fusionne le soft seating avec le bureau à l'aide d'une structure en plateforme robuste légère, qui permet de connecter et de lier une multitude de modules dans un espace.

Mit dem Sitzsystem Longo kann man seine Leistungsfähigkeit zurückerlangen. Longo fusioniert das Konzept des Soft Seatings mit den Ansprüchen eines Büros. Dazu wurde eine von der Struktur her robuste, ästhetisch jedoch leichte Plattform entwickelt, die als Bindeglied für die einzelnen Module zur Gestaltung des Raums dient.

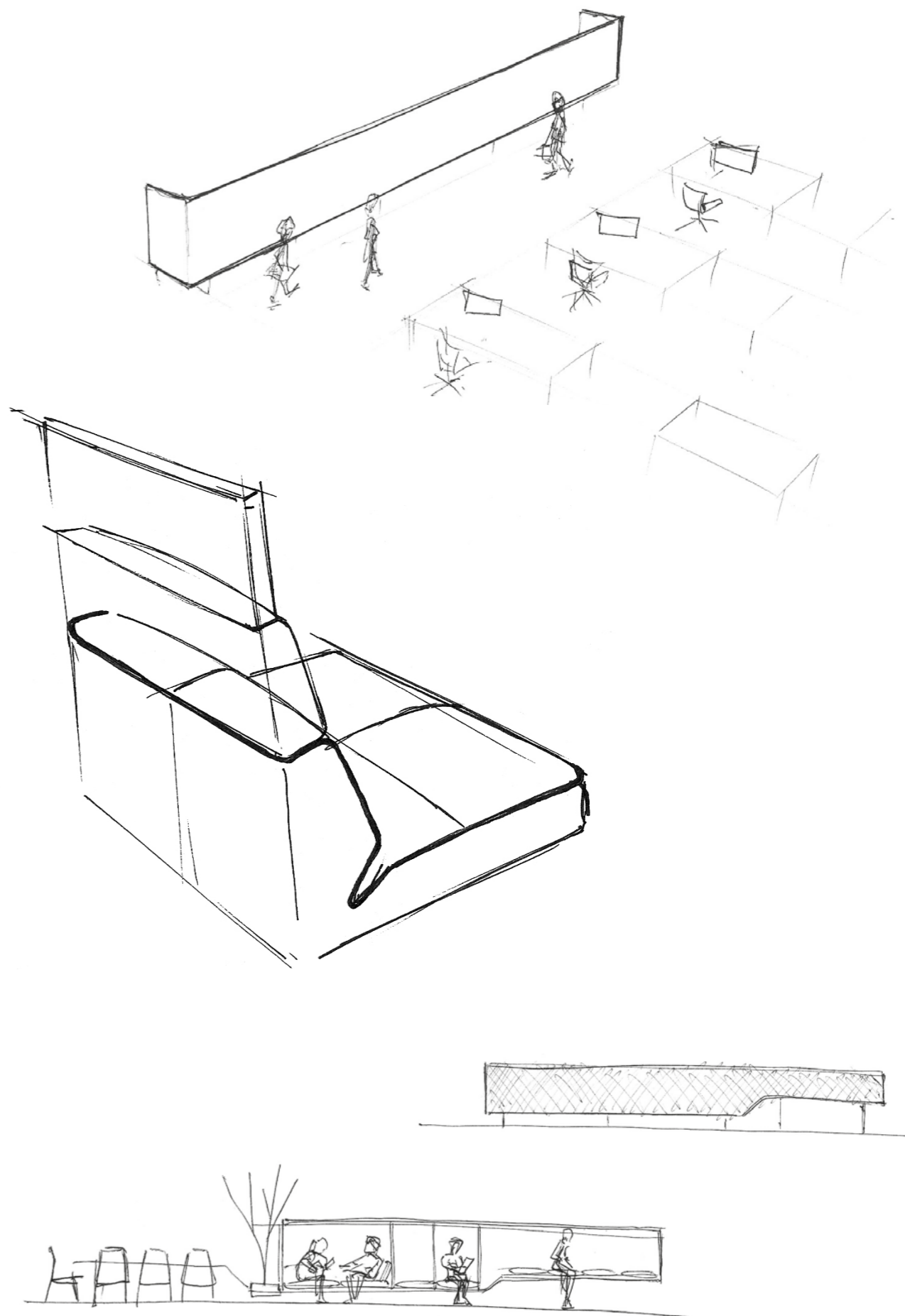
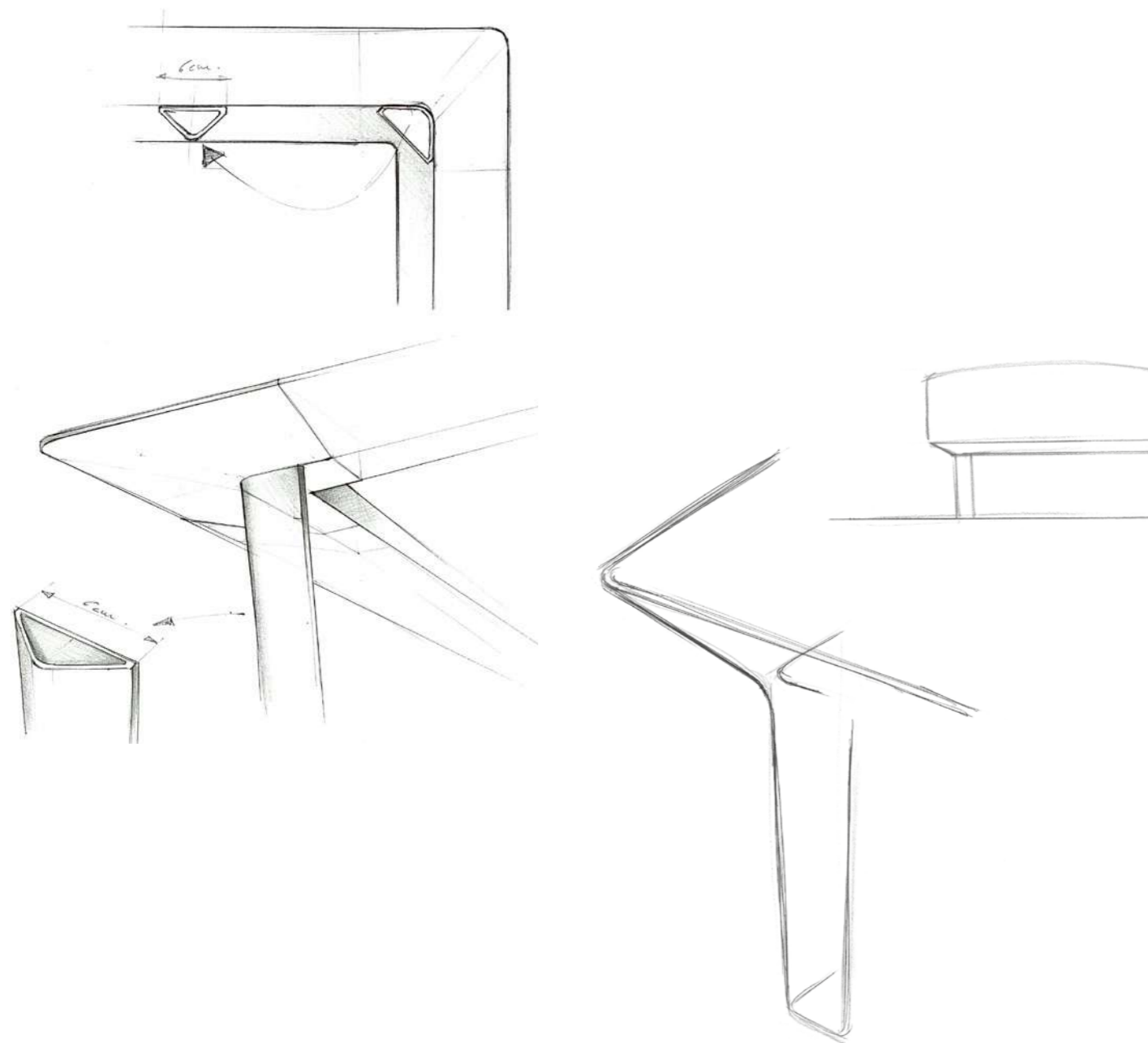







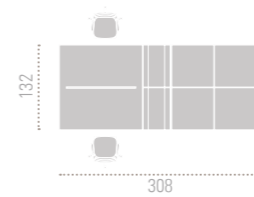
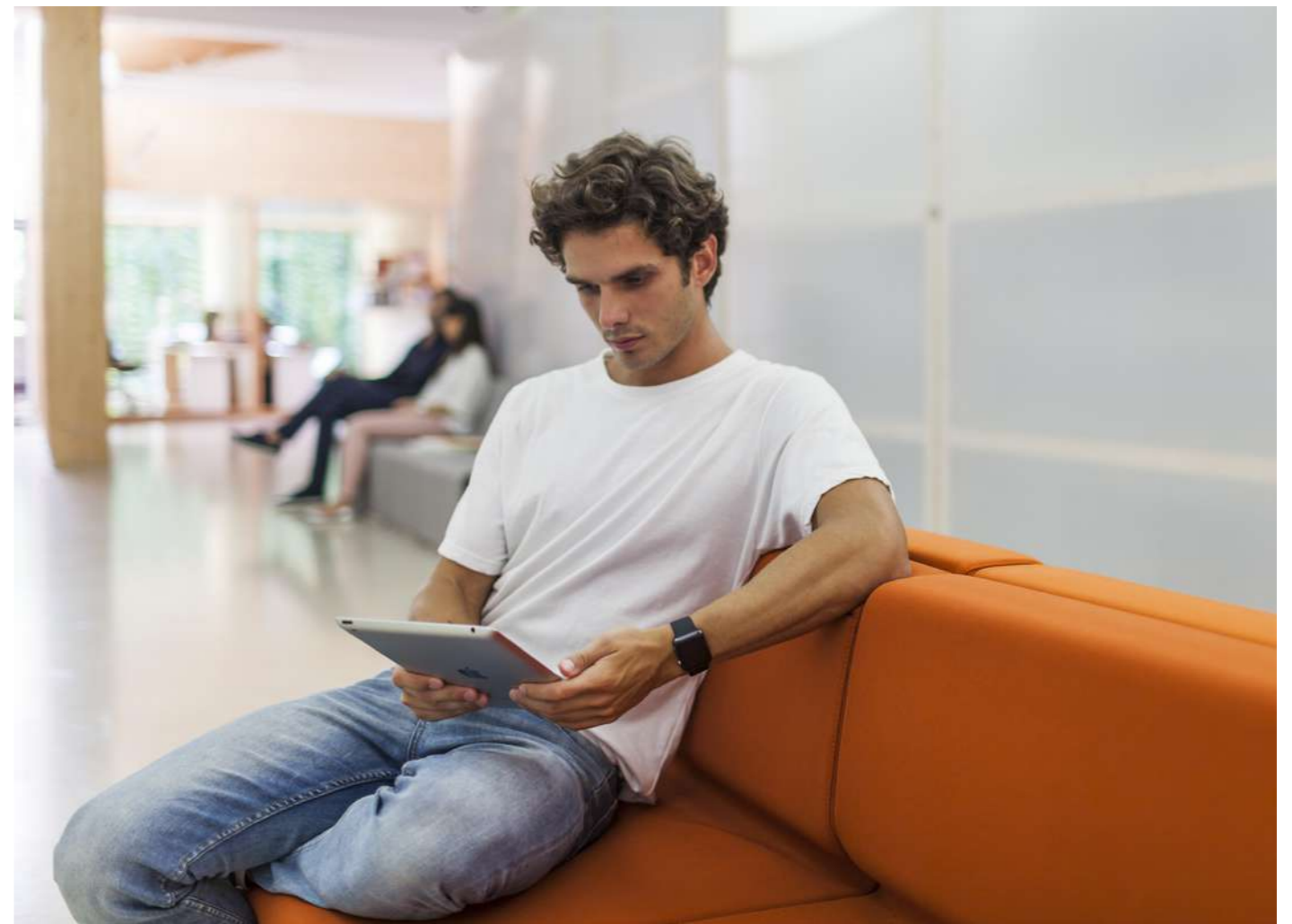

MAXIMUM VERSATILITY FOR ALL TYPES OF SPACES AND PROJECTS



# LONGO

LOUNGE SEATING



Sometimes daily work becomes routine, pressure blocks our creativity which we wish to avoid so we need somewhere to escape to , to disconnect, relax, breathe deeply and help us restore the optimal level of performance. And what if we told you that this was all possible? and if we told you that it already exists and it is called Longo? Now you don't have to leave the office to disconnect....

En ocasiones el trabajo diario se convierte en rutinario, la presión bloquea nuestra creatividad y nos gustaría poder evadimos y escapar a otro lugar donde desconectar, relajarnos, poder respirar profundamente para recuperar el nivel óptimo de rendimiento. ¿Y si te contáramos que todo esto es posible? y si te dijéramos que ya existe y se llama Longo? Ya no hace falta salir de la oficina para desconectar...

Parfois le travail devient routinier, le stress bloque notre créativité et nous préférons fuir et nous évader vers d'autres lieux pour changer, se relaxer, respirer profondément afin d'optimiser nos performances. Et si tout cela était possible ? Et si cela existait déjà ? Il se nomme Longo. Il n'est plus nécessaire de partir du bureau pour se déconnecter...

Manchmal wird die tägliche Arbeit zur Routine, unter Druck blockiert sich unsere Kreativität und wir möchten einfach mal raus, einen Ort aufsuchen, wo wir abschalten, uns entspannen, tief atmen können, um wieder leistungsfähig zu werden. Und wenn das tatsächlich geht? Wenn es diesen Ort nun wirklich gibt? Er hat sogar schon einen Namen: Longo. Um mal auszuspannen, braucht man das Büro jetzt nicht einmal mehr zu verlassen ...





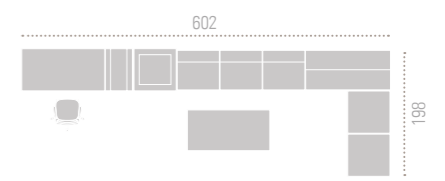







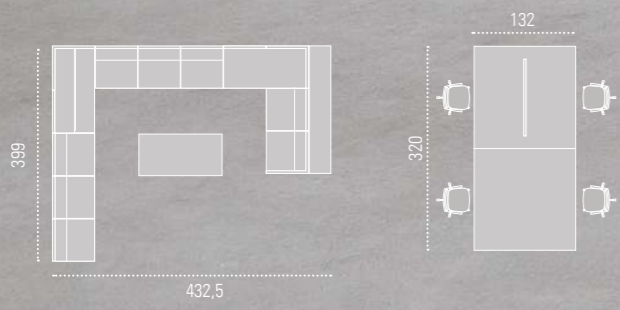



Longo is a modular system consisting of sofas, operative and managerial desks, with storage solutions ( cabinets, libraries) , accessories and sound absorbing panels which incorporate decorative accessories and items that inspire a cheerful environment.

Longo es un sistema modular compuesto por sofás, mesas operativas y direccionales, con soluciones de almacenamiento (armarios, librerías), accesorios y panelaciones fonoabsorbentes, que incorpora accesorios y elementos decorativos que nos inspiran alegrando el entorno.

Longo est un système modulaire composé de fauteuils, de tables opératives et de direction avec des solutions de rangement (armoires, bibliothèques), des compléments et des panneaux écrans à isolation phonique. Tout ceci peut se compléter d'accessoires ou d'éléments décoratifs qui nous inspirent.

Longo ist ein modulares System mit Sofas, Arbeitstischen und repräsentativen Tischen, Aufbewahrungsmöglichkeiten (Schränke, Regale), Accessoires und schalldämmenden Tafeln. Dabei sind alle Elemente und Accessoires so gestaltet, dass sie uns inspirieren und die Umgebung freundlich gestalten

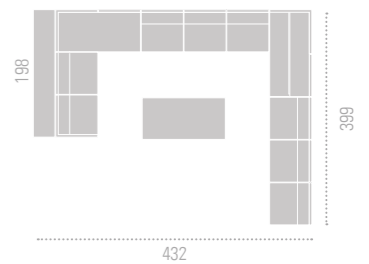







DECORATIVE ACCESSORIES AND ITEMS  
THAT INSPIRE A CHEERFUL ENVIRONMENT





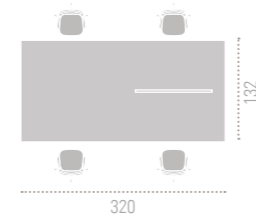





LONGO storage results in an optimal solution for the user requiring filing systems that do not impede visually and provide an efficient solution for daily storage, self-configuring and modular.

Los armarios LONGO resultan una solución óptima para el usuario que requiera de sistemas de archivo que no supongan un obstáculo visual y proporcionen una solución eficiente para el almacenaje diario.

Le résultat obtenu avec les armoires longo est une solution optimale pour l'utilisateur qui recherche des systèmes de classeurs qui ne représentent pas un obstacle visuel tout en apportant une solution efficace au rangement quotidien.

Die schränke LONGO sind eine optimale Lösung für den Benutzer, der ein Aufbewahrungssystem benötigt, das kein optisches Hindernis darstellt und eine effiziente Lösung zur täglichen Aufbewahrung bietet.





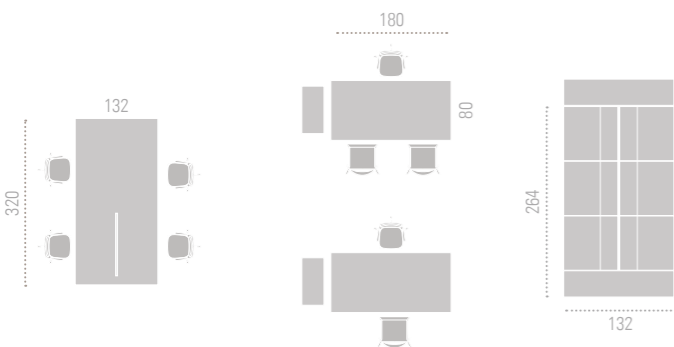

LONGO FUSES SOFT SEATING WITH THE OFFICE







Longo stems from a solid extruded aluminium structure on which we attach the cast iron legs and endless possibilities to achieve the desired environment, always maintaining a unitary visual concept.

Longo nace de una sólida estructura de aluminio extrusionado sobre la que adaptamos patas de inyección de aluminio y un sinfín de posibilidades hasta conseguir el ambiente deseado, siempre manteniendo un concepto visual unitario.

Longo est née d'une solide structure en aluminium extrudé sur laquelle nous avons adapté un piétement en injection d'aluminium. Nous pouvons obtenir une infinité d'environnements tout en ayant un concept unitaire visuel.

Longo ist eine solide Struktur aus stangengepresstem Aluminium, an der die Beine aus Druckgussaluminium angebracht werden. Eine Struktur, die uns eine Unzahl von Gestaltungsmöglichkeiten für den uns vorschwebenden Raum eröffnet, dabei jedoch stets einem klaren ästhetischen Konzept treu bleibt.





NOW YOU DON'T HAVE  
TO LEAVE THE OFFICE  
TO DISCONNECT

---

---









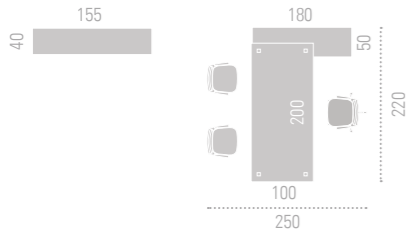

Polished finish detail  
Detalle de canto pulido



# LONGO

EXECUTIVE DESKS







DISCRETE, MODULAR  
AND EFFECTIVE

---

---





MAKE YOUR  
OWN LONGO



CREA TU PROPIO LONGO



DESKS

STRAIGHT DESKS

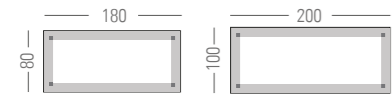

LNM15 LNM16

DESKS WITH CREDENZA SUPPORT

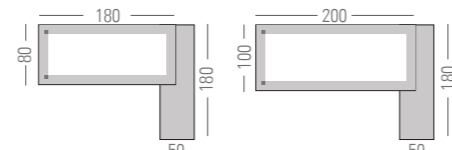

LNM75 LNM76

CONTRACT DESKS

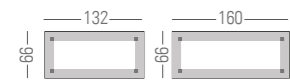

LNM63 LNM65

AUXILIARY DESKS. HEIGHT 32 CM

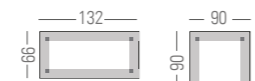

LNM02 LNM03

MEETING TABLES AND EXECUTIVE DESKS

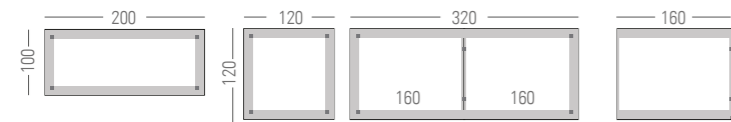

LNM16 LNM43 LNM48 LNM480  
Progressive desk

TWIN DESKS - WIDTH 132 CM

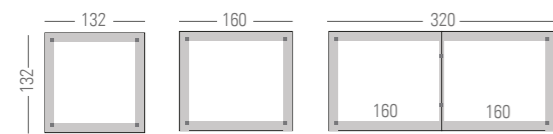

LNM53 LNM55 LNM58

DOUBLE DESKS AND MIDDLE EXTENSIONS - WIDTH 160CM

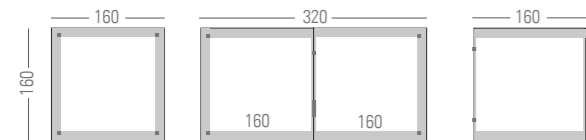

LNM85 LNM88 LNM880  
Progressive desk

FILING SYSTEMS

CABINETS - SIDEBOARD

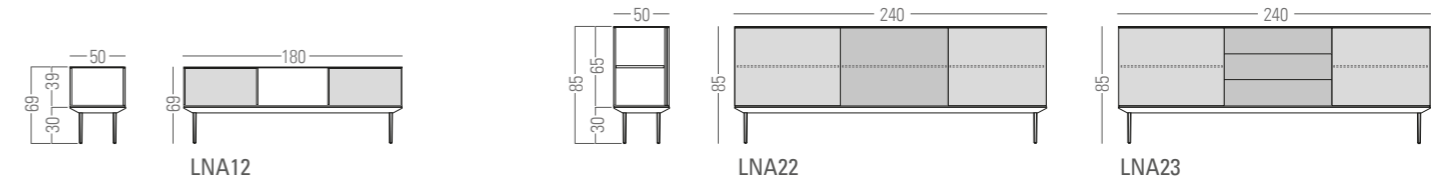

AUXILIARY CUPBOARDS

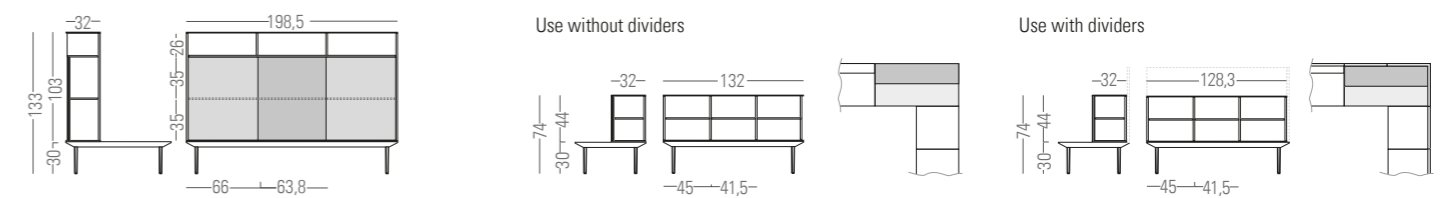
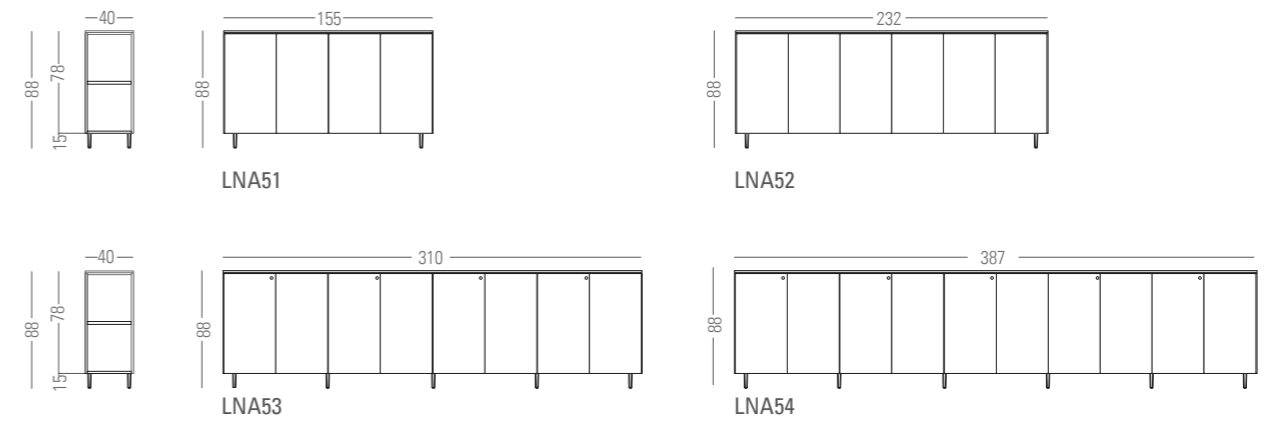



MODULES WITHOUT DIVIDING

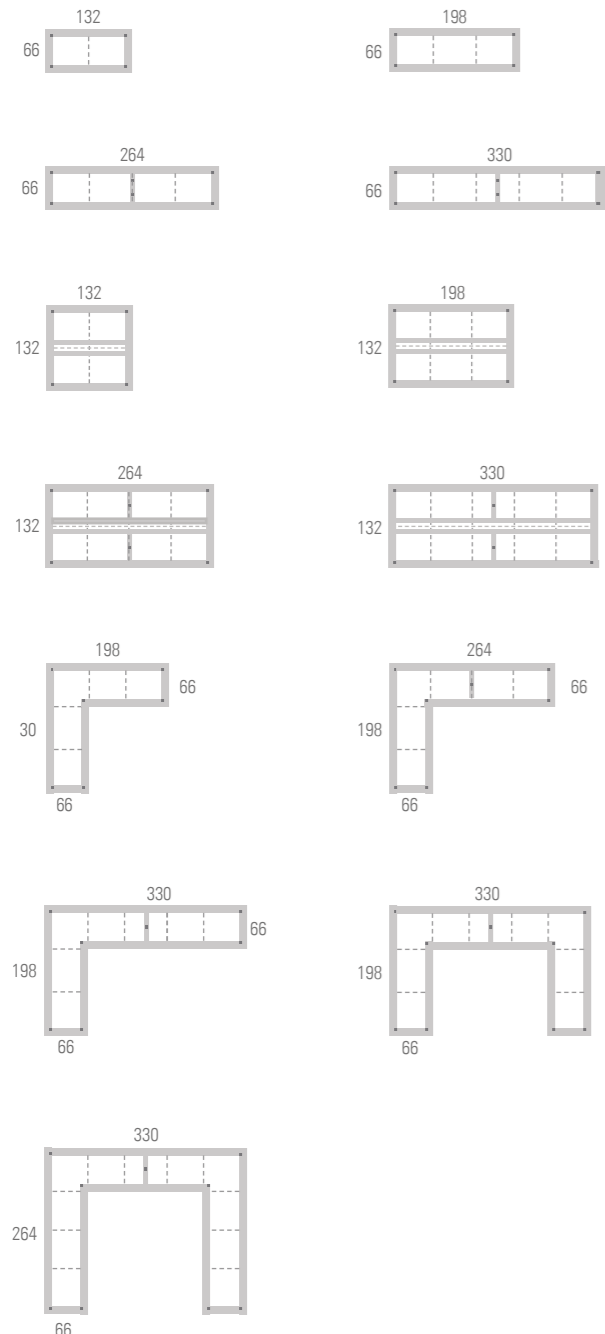
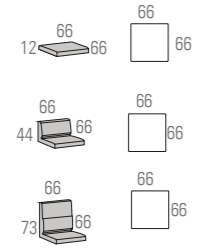

MODULES WITH DIVIDING H=45 CM

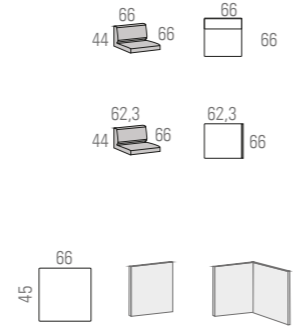

Rear or Side Panel  
90° Corner Panel

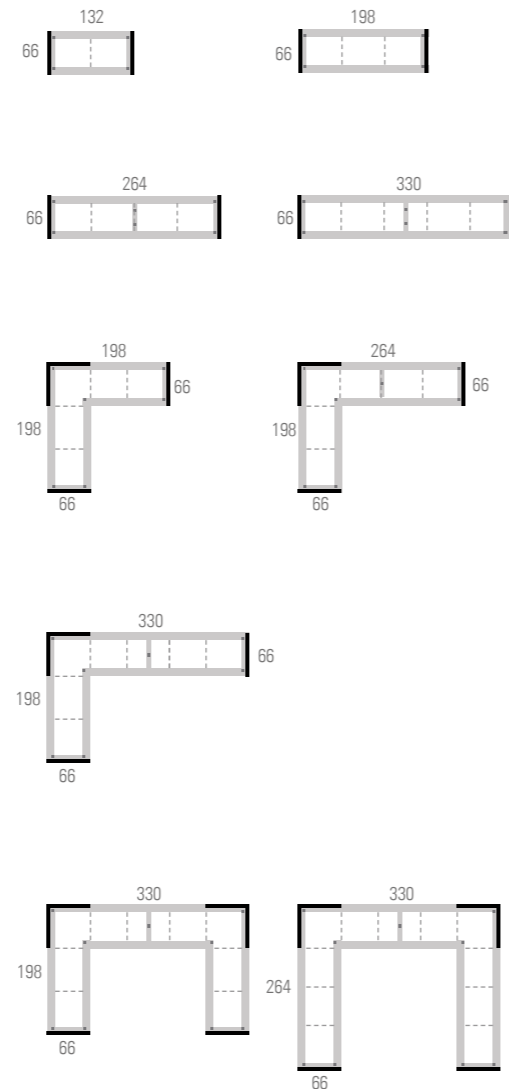

MODULES WITH DIVIDING H=74 CM

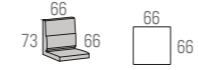

90° Corner Panel

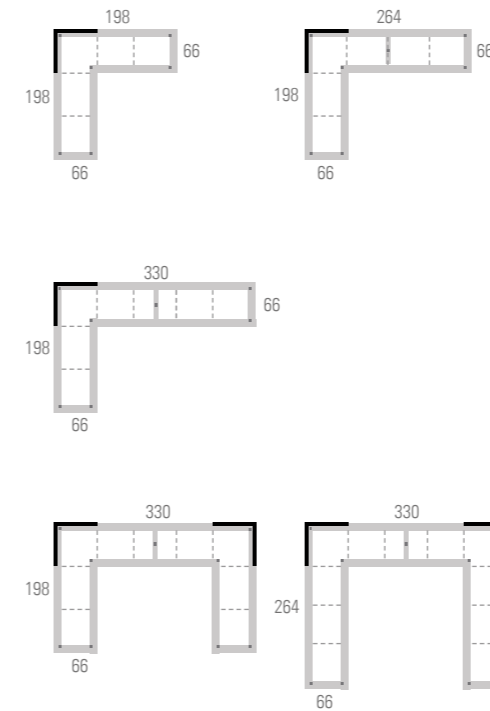

MODULES WITH DIVIDING H=103 CM



Rear or Side Panel  
90° Corner Panel

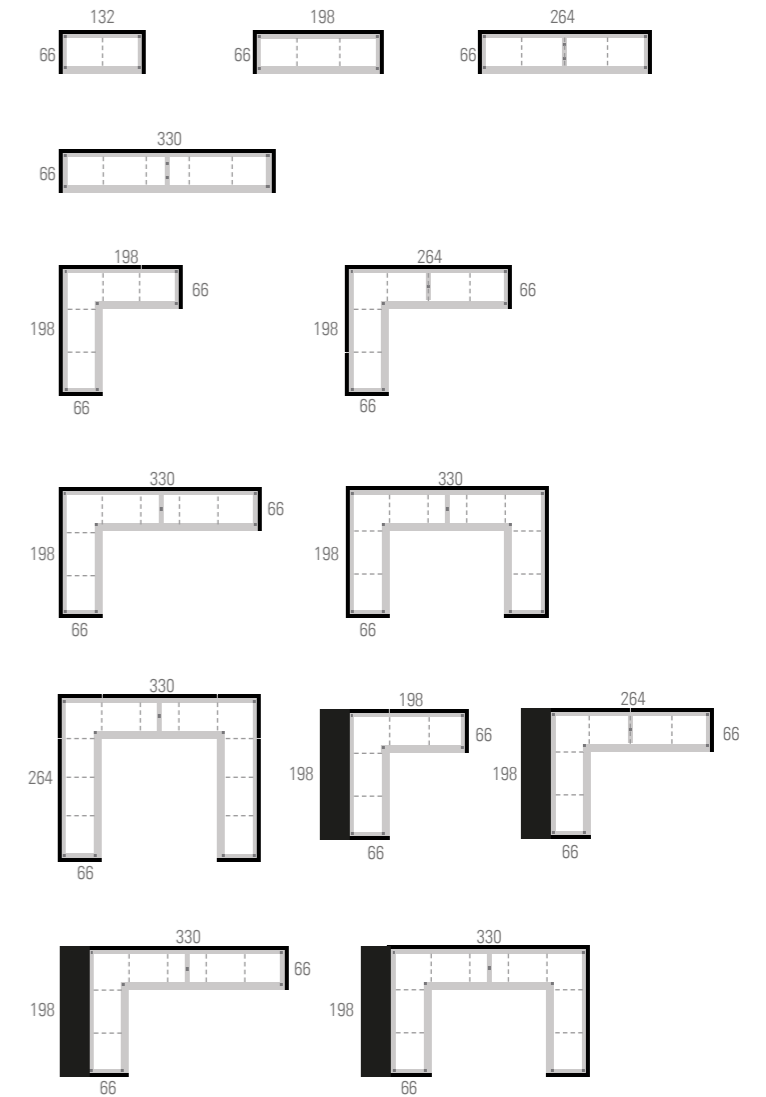



LONGO PROGRESSION

PROGRESSION BOTH SIDES

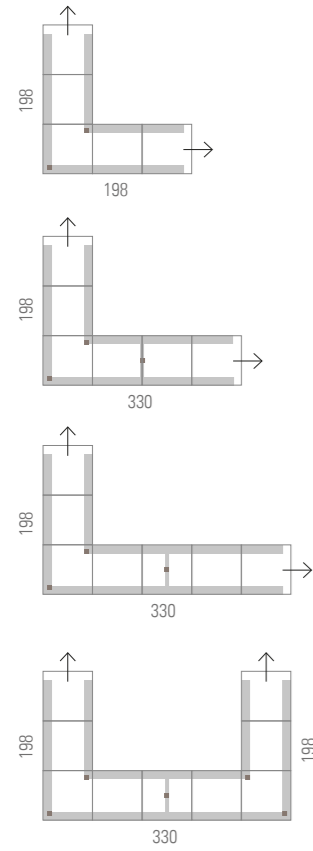
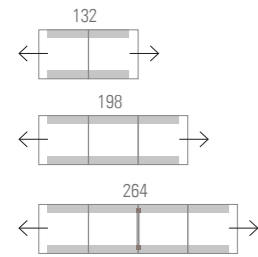

PROGRESSION ON ONE SIDE

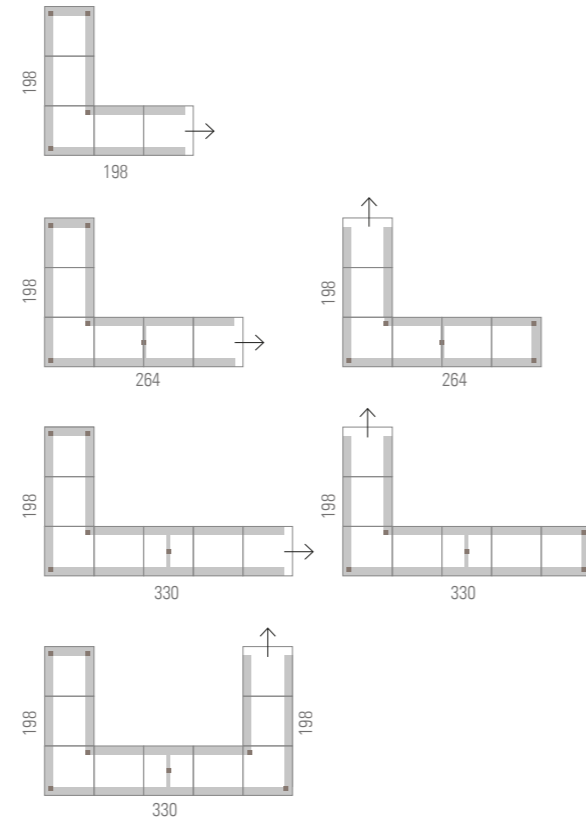
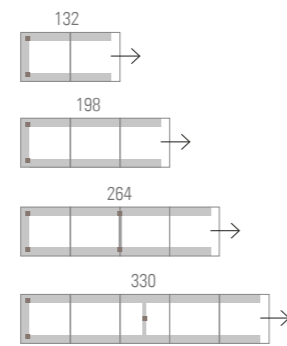

DESKS

CONTRACT DESKS

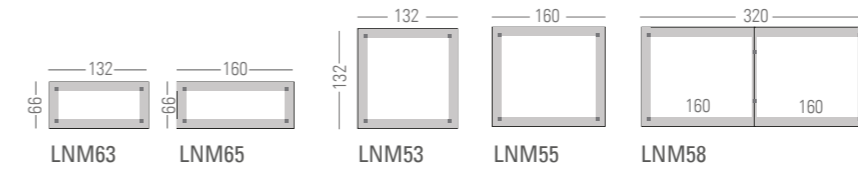

COFFEE TABLES HIGHT 32 CM

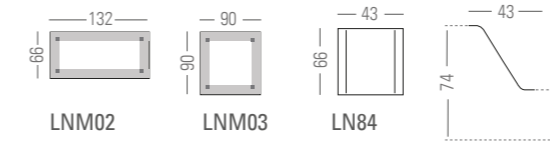

ACCESSORIES



Table Top dividers

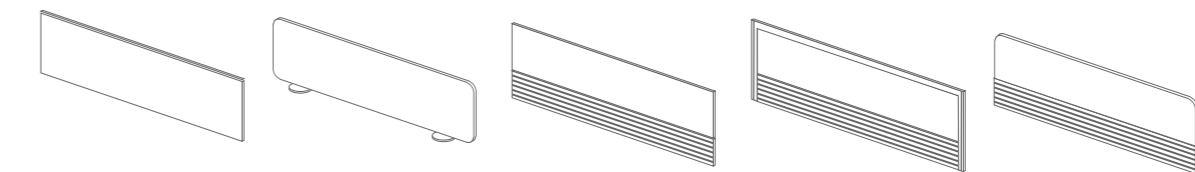

Electrification systems

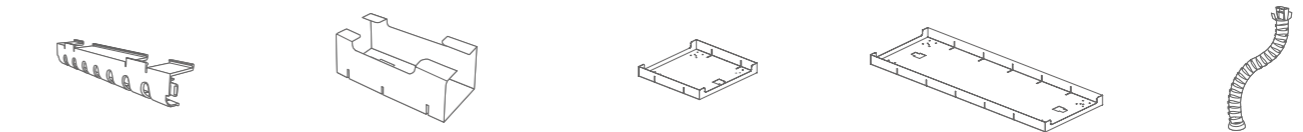



COMPOSITION EXAMPLES. DEFINED CONSTRUCTION

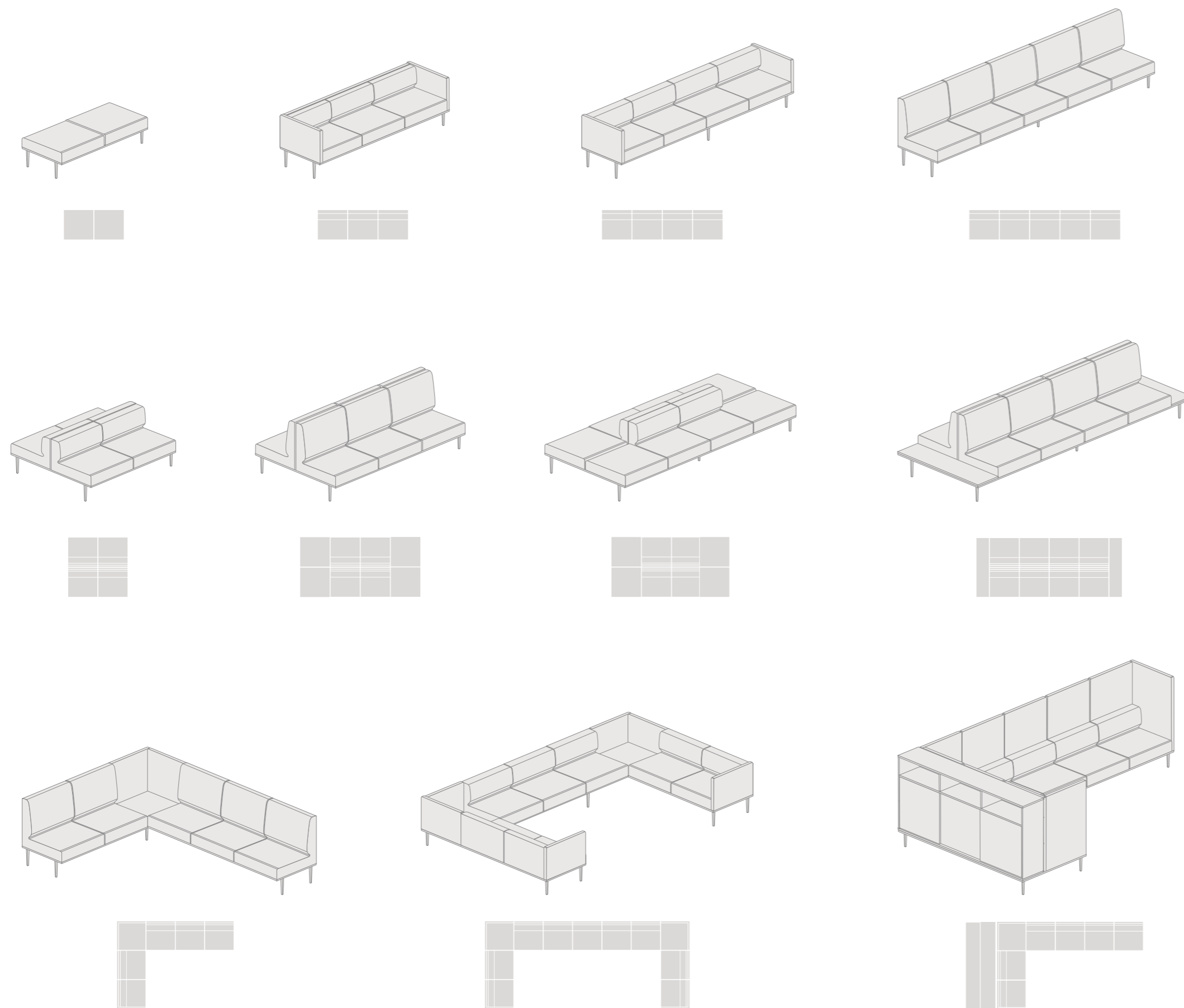

**MAKE YOUR LONGO PROJECTS  
COME TRUE ACTIU PLANNER**

**Fast, Easy, Visual.**  
The Actiu software with intelligent product libraries, allows you to visualize and do great quality virtual animations.



COMPOSITION EXAMPLES. DEFINED CONSTRUCTION

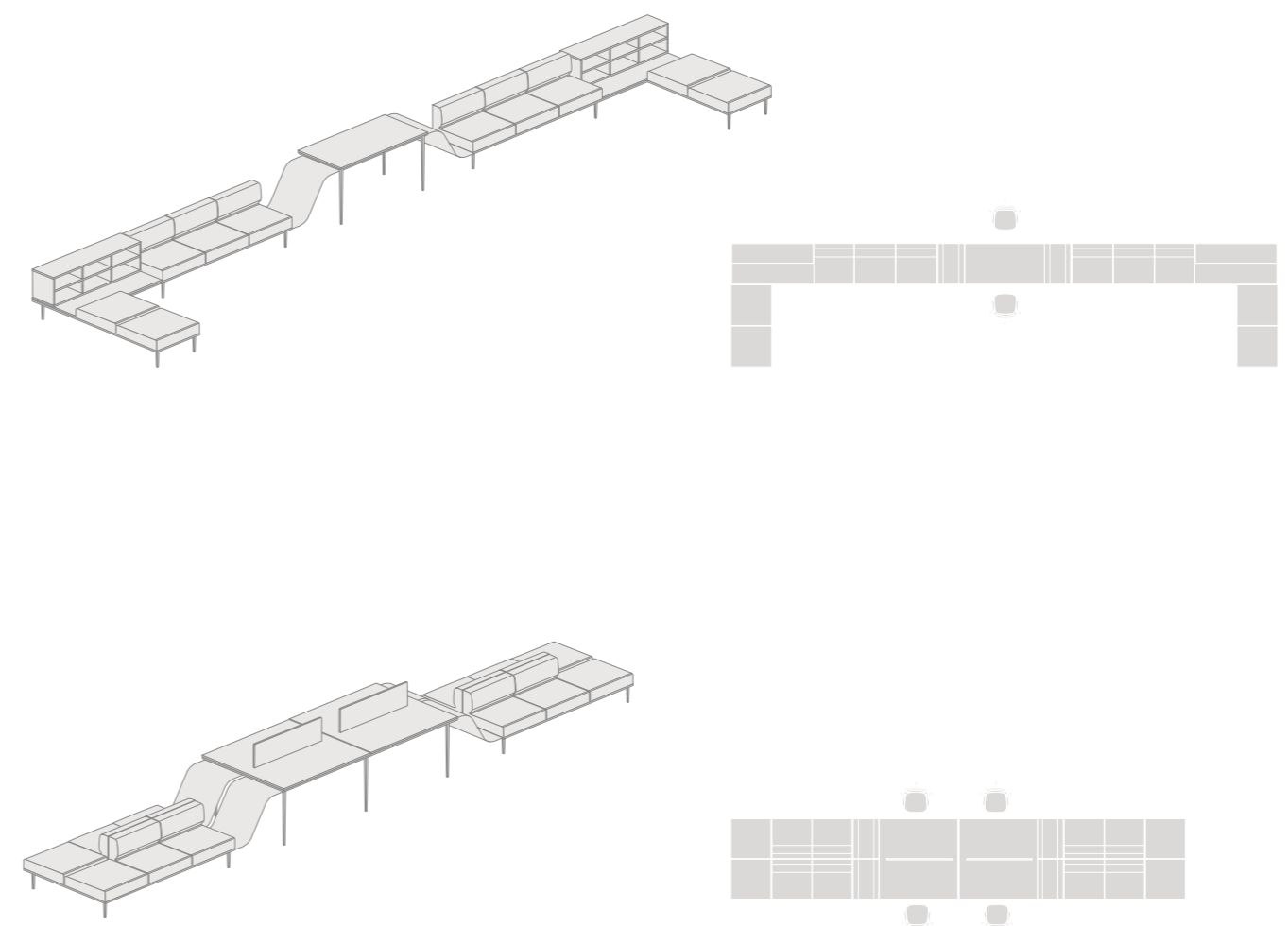
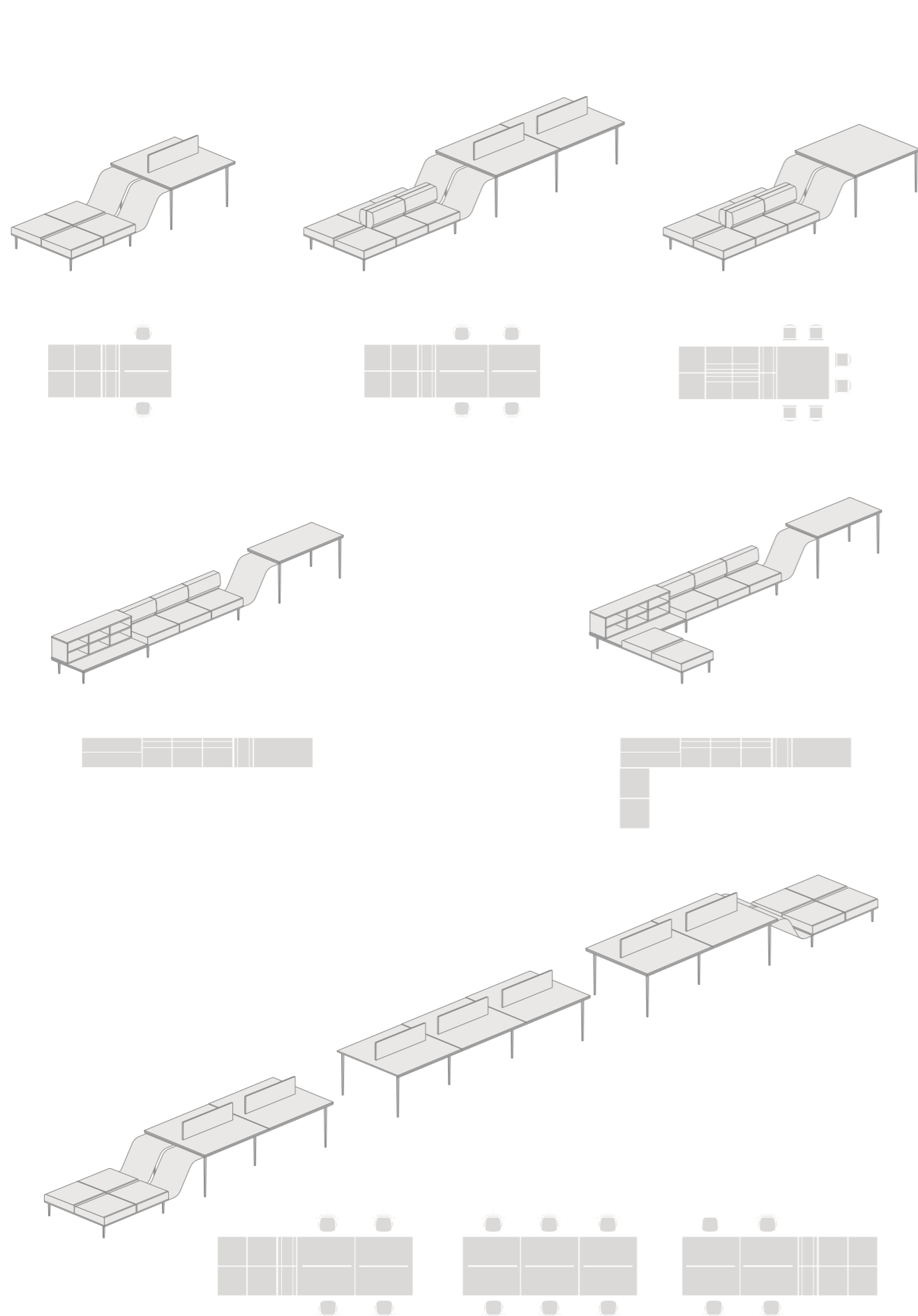

Longo enables more friendly, open and relaxed environments, where formal structures and dynamic spaces thrive to create a harmonious environment.

Longo permite dibujar entornos de trabajo más amables, abiertos y distendidos, donde las estructuras formales y espacios dinámicos se nutren entre ellas para crear un ambiente armonioso.

Longo nous permet de dessiner dans des espaces de travail plus agréables, ouvert et conviviaux, où les structures formelles et les espaces dynamiques s'enrichissent entre elles pour créer un environnement harmonieux.

Longo erlaubt die Gestaltung gemütlicher, offener und entspannter Bereiche im Arbeitsumfeld, wo sich die formalen Strukturen in perfekter Harmonie mit den durch sie geschaffenen Räumen durchdringen.



COMPOSITION EXAMPLES. AD-HOC CONSTRUCTION

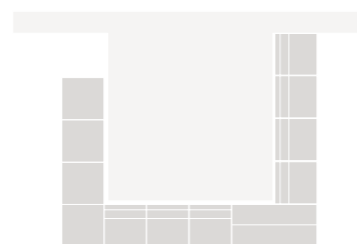
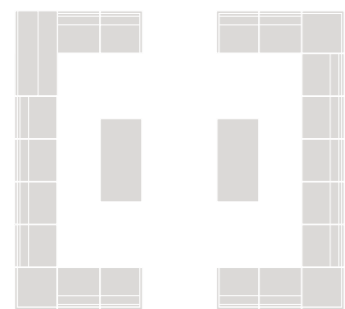
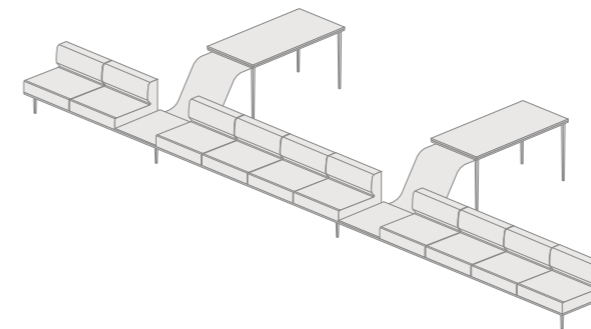
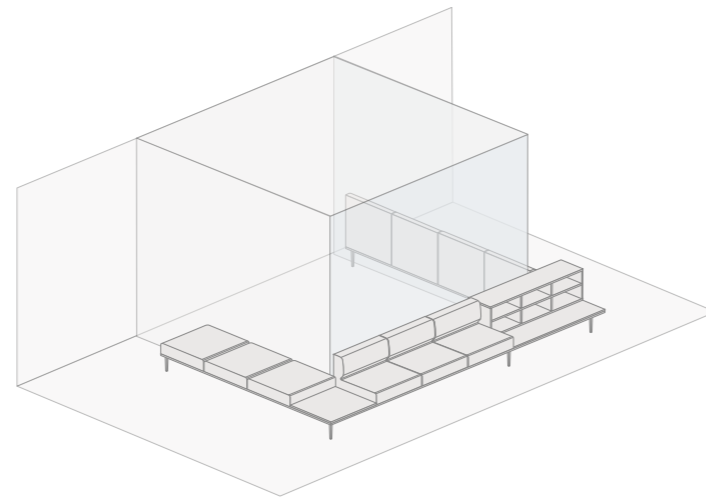
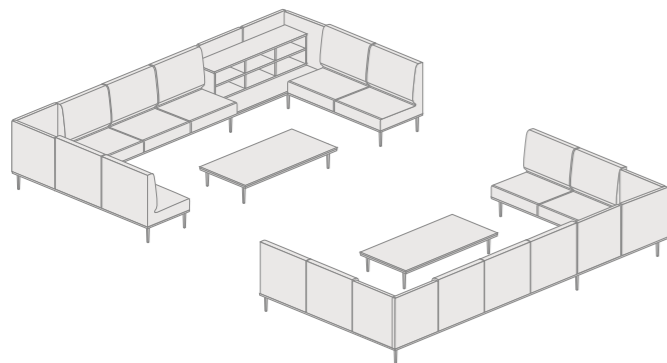
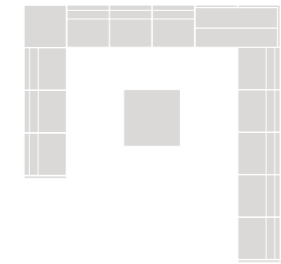
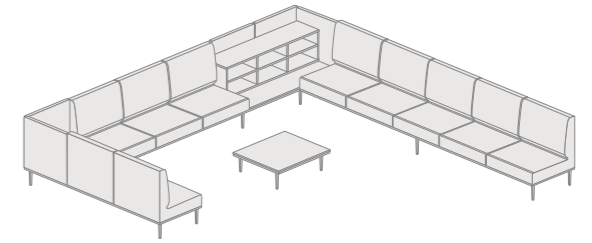
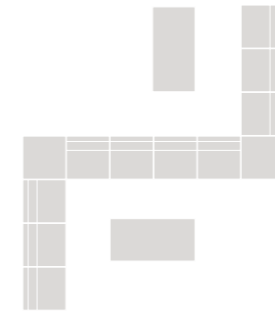
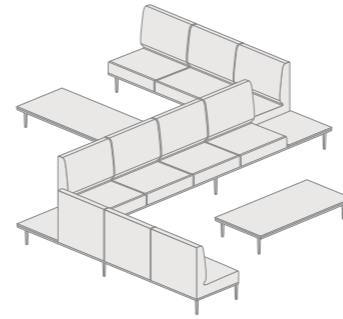
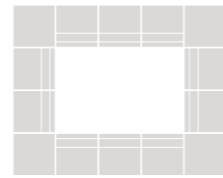
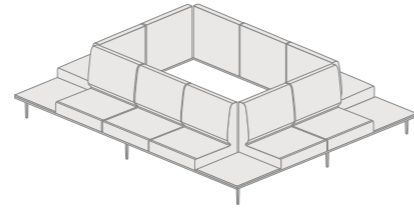
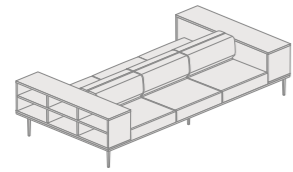





## ACTIU

### 47 YEARS DESIGNING PUBLIC AND WORK SPACES

Actiu is a company with an industrial career in the installation sector, specializing in the creation of furniture, whose flexibility and productive capacity allow the development of global sourcing projects at an international level offering solutions which provide for the welfare of people.

#### ACTIU TECHNOLOGY PARK A sustainable industrial project.

A flexible, open and transparent architecture space. A project with new prospects certified by LEED® Gold for all the existing buildings that point Actiu as a referent in Europe.

Energetic production solar plant: 7.000.000 kWh per year

Rainfall water collection (12.000 m³ capacity)

Water Tanks: 12.000 m³

Meeting points, club and nursery service

Green areas: 130.000 m²

Total Industrial surface: 200.000 m²

Corporate Headquarter building: 6.000 m²

Logistics centre: 18.000 m²

Production plants: 40.000 m²



ACTIU TECHNOLOGY PARK  
project certified as LEED® GOLD  
by U.S. Green Building Council 2011  
Leadership in Energy & Environmental Design



ACTIU TECHNOLOGY PARK

#### ACTIU TECHNOLOGY PARK

Architecture linked to the local industry  
A philosophy turned into architecture.

Architect: José María Tomás Llavador

#### DESIGN & ARCHITECTURE

Space management and design  
Products. Own patents  
Communication

#### SUSTAINABILITY

Sustainable production  
Product. Eco-design  
Services, effective logistics system  
Actiu Technology Park, certified LEED® Gold

#### MANUFACTURER

We are manufacturers  
Domain raw materials and processes  
Technology and Innovation  
Standardized and specific solutions

#### GLOBAL COVERAGE

Presence in more than 65 countries  
Global equipment solutions. Corporate, Health,  
Education, Contract, Transport,...







## LIFE CYCLE ANALYSIS

### ENVIRONMENTAL PRODUCT DECLARATION



**MATERIALS:**  
Including the extraction and processing of raw materials and component sourcing to its delivery at the Actiu Technology Park.



**PRODUCTION:**  
Consider the production and assembly processes used in Actiu.



**TRANSPORT:**  
Includes transportation from the Actiu Technology Park to the our customers facilities ( light commercial transport).

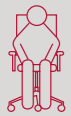

**USE:**  
This stage has not environmentally relevance for life cycle analysis.



**DISPOSAL:**  
Any product can be disposed of in different ways, or become a resource. Aluminum, wood and cardboard packaging is recycled, while the rest is treated as urban waste.

## CERTIFICATES AND REFERENCES

ACTIU products fulfill all demands about management, quality and sustainability to provide extra value to the projects using recycled materials to get the recyclable final product.



Actiu has made this document with 100% recycled paper reducing environmental impact as follows:

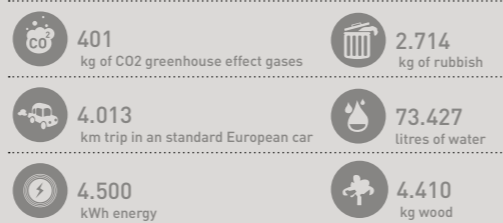





[www.actiu.com](http://www.actiu.com)