

GUSTAVE



Signature
— BY EOL —



PRATIQUE & MULTIFONCTIONNEL

Conçu pour optimiser la surface de travail du bureau, GUSTAVE est le rangement de proximité idéal. Décliné en version individuelle ou partagée, GUSTAVE offre une utilisation quotidienne à la fois pratique et agréable, améliorant l'accessibilité et l'utilité de vos rangements. Avec plus de 200 combinaisons de couleurs, allant des teintes boisées ou pastels aux couleurs toniques, il s'inscrit dans tous les styles SIGNATURE BY EOL et permet d'apporter de la couleur par petite touche. Avec ses nombreux accessoires optionnels, GUSTAVE est ultra-personnalisable.

PRACTICAL & VERSATILE

Designed to maximise the available space on a desk's worktop, GUSTAVE is the perfect easy reach storage solution. GUSTAVE is available in individual and shared use versions that optimise storage space and improve accessibility, whilst at the same time ensuring an enjoyable and practical user experience. With its extensive palette of over 200 colour combinations, ranging from lighter pastels to a more vibrant spectrum of colours, GUSTAVE will fit in with the entire SIGNATURE BY EOL catalogue of styles and inject its own colourful highlights into the mix. With an extensive selection of optional accessories, GUSTAVE is a truly ultra-customisable storage unit.

PRAKTISCH & MULTIFUNCTIONEEL

GUSTAVE werd ontwikkeld om het werkoppervlak te optimaliseren en biedt praktische opberg ruimte binnen handbereik. GUSTAVE bestaat in individuele of gedeelde uitvoering en is een gebruiksvriendelijke, elegante en toegankelijke aanvulling bij het bureau. Met meer dan 200 kleurencombinaties, gaande van houtdecors en pasteltinten tot opvallend felle kleuren, passen deze elementen bij alle SIGNATURE BY EOL stijlen en voegen ze een dynamisch accent toe aan uw kantooromgeving. GUSTAVE kan aangevuld worden met talrijke opties.

RANGEMENT PERSONNEL OU PARTAGÉ
INDIVIDUAL OR SHARED STORAGE
PERSOONLIJKE OF GEDEELDE OPBERGRUIMTE



Version hauteur bureau pour prolongement de poste
Desk height version, providing a useful additional work surface
Versie op bureauhoogte in het verlengde van het bureau



Version haute partagée pour rangement collectif, avec case personnelle sécurisée
Shared high version, for collective storage use and featuring a lockable individual compartment.
Hoge versie voor gedeelde opbergruimte, met vergrendelbaar persoonlijk vak

CLOISONNER L'ESPACE
CLEARLY DEFINED SPACES
DE RUIJMTE INDELEN



Version haute individuelle pour séparer l'espace
Individual high version, helps define the workspace
Hoge individuele versie voor indeling van de ruimte

PERSONNALISER GUSTAVE
CUSTOMISE GUSTAVE
GUSTAVE PERSONALISEREN



GUSTAVE se décline en plus de 200 combinaisons de couleurs. A vous de choisir votre GUSTAVE ! Pour aller plus loin dans la personnalisation, optez pour des accessoires pratiques, des tablettes ou encore un rail pour dossiers suspendus afin d'organiser le rangement. Des options d'électrification complètent aussi cette gamme.

GUSTAVE is available in over 220 different colour combinations. Choose a GUSTAVE to your liking ! Taking customisation even further and to help you better organise your storage, GUSTAVE can be fitted with 5 practical accessories, a number of shelves and a suspension file rail. Power and data connectivity options further complete the offering.

GUSTAVE is leverbaar in meer dan 220 kleurencombinaties. Aan u de keuze ! Om GUSTAVE nog verder te personaliseren zijn er 5 praktische accessoires, legborden en een rail voor hangmappen. De connectiekoplossingen vervolledigen het aanbod.

OPTIONS

OPTIONS

OPTIES



Points d'électrification (uniquement pour la version individuelle)
Power and data feeds (individual high version only)
Aansluitpunten (alleen voor individuele versie)



Fileur⁽¹⁾
Fillet of decorative trim⁽¹⁾
Decoratieve naad⁽¹⁾



Tablette support pour dossiers suspendus
Shelf with hanging rail for suspension files
Legbord voor hangmappen

⁽¹⁾Visuel non contractuel - Actual product may differ from photographs - Afbeelding niet bindend

Accessoires - Accessories - Accessoiries

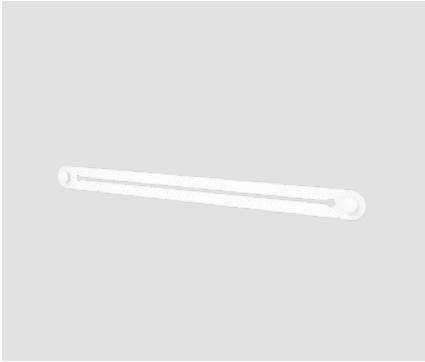

Rail pour accessoires
Accessory rail
Rail voor accessoires



Bac à courrier départ/suivant
Letter tray - starter/add-on
Postbakje basis/opbouw

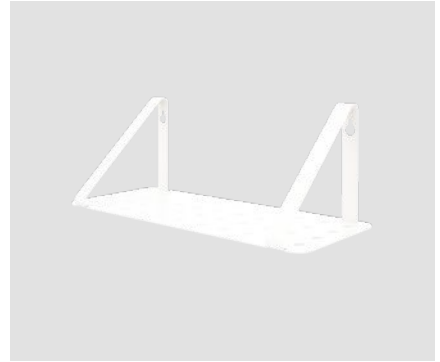

Étagère
Shelving
Legbord



Tableau magnétique
Magnetic whiteboard
Magneetbord



Jardinière 3 bacs
Planter with 3 compartments
Plantenhouder met 3 bakken

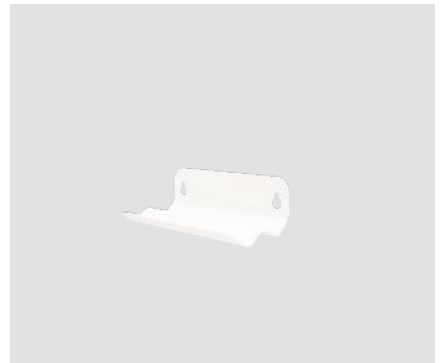

Plumier
Pen tray
Pennenvakje

GAMME RANGE COLLECTIE

Caissons pour poste individuel - Pedestal for individual workstation - Opbergmodule voor vrijstaand bureau



Version standard, top inclus
Standard version, decorative top included
Standaardversie, inclusief topblad



Version haute, top inclus
High version, decorative top included
Hoge versie, inclusief topblad

Caissons pour poste partagé - Pedestal for shared workstation - Opbergmodule voor gedeeld bureau



Version haute
High pedestal version
Hoge versie

SYNOPTIQUE OVERVIEW OVERZICHT

Caissons pour poste individuel - Pedestal for individual workstation - Opbergmodule voor vrijstaand bureau

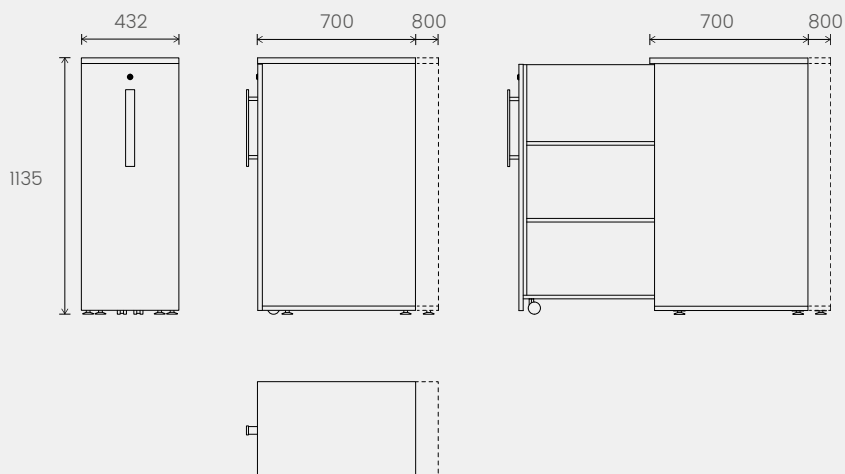
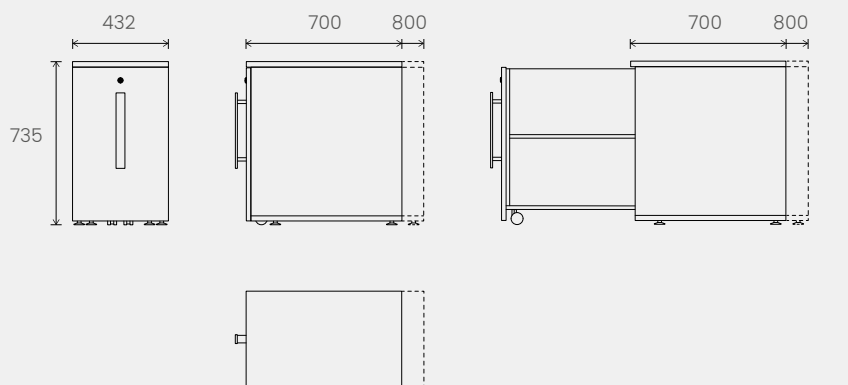

Caissons pour poste partagé - Pedestal for shared workstation - Opbergmodule voor gedeeld bureau

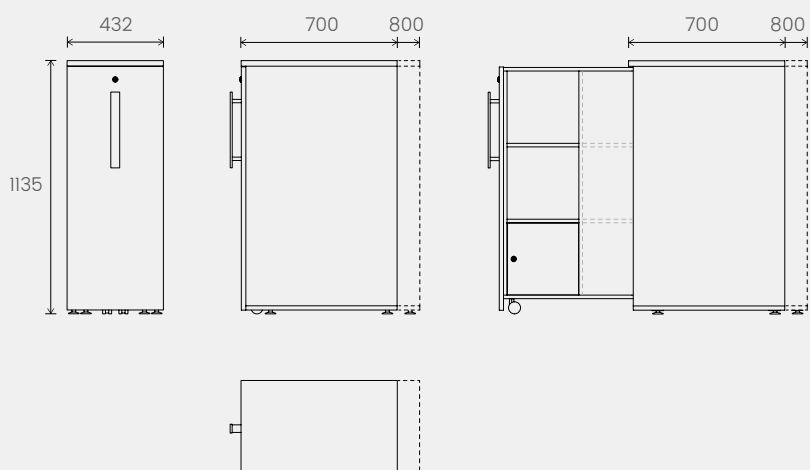

1. MÉLAMINE (corps d'armoire⁽³⁾) – MELAMINE (storage unit shell⁽³⁾) – MELAMINE (ambouw⁽³⁾)



2. MÉLAMINE (façades⁽³⁾⁽⁴⁾) – MELAMINE (front⁽³⁾⁽⁴⁾) – MELAMINE (iadefront⁽³⁾⁽⁴⁾)

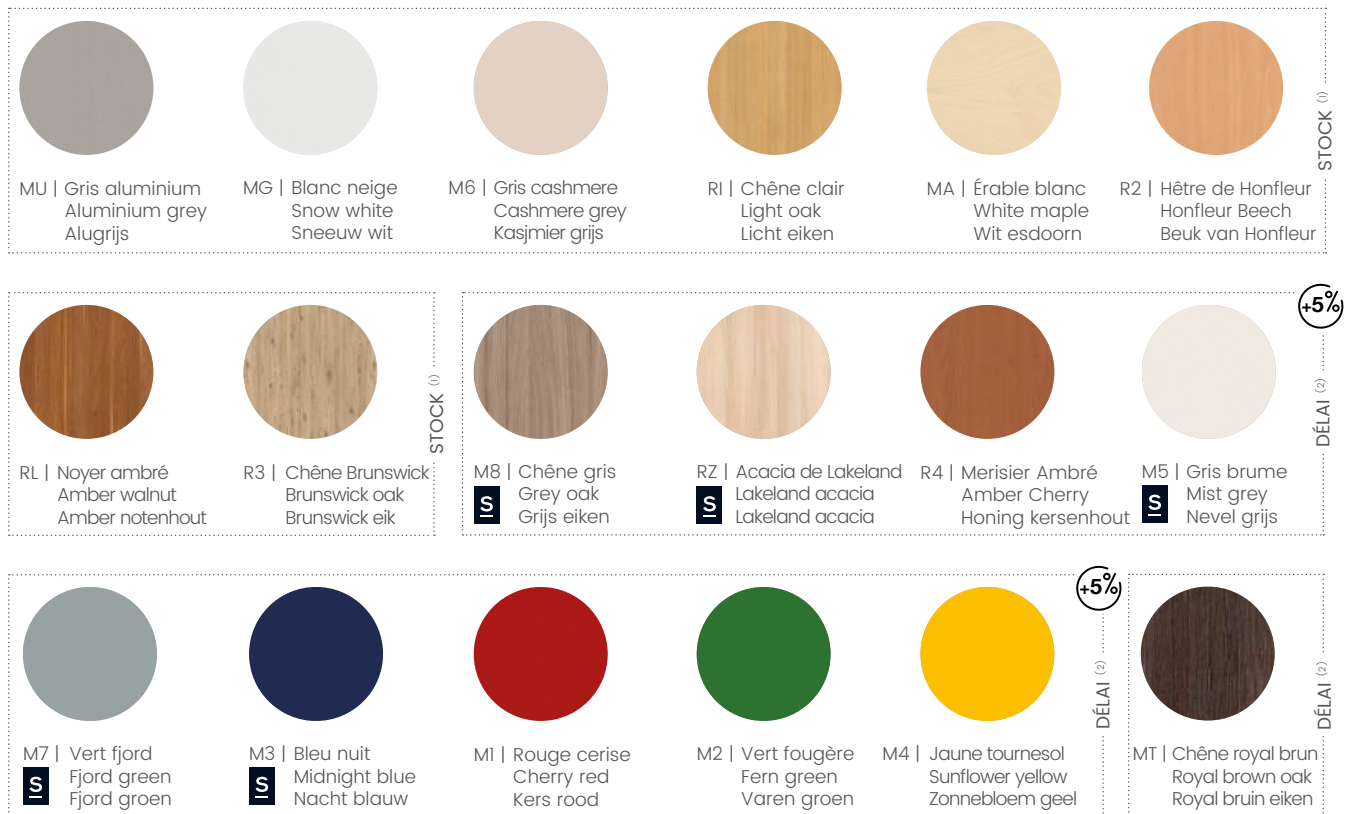

+5% majoration de 5% sur le PP HT indiqué
5% mark-up on the RRP excl. tax
meerprijs van 5% op de opgegeven verkopprijs excl. BTW











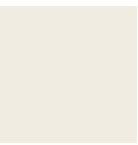

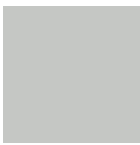



⁽¹⁾ STOCK / STOCK / VOORRAAD
⁽²⁾ DÉLAI / ON REQUEST / MET LEVERTIJD

S Exclusivité / Exclusive to / Exclusiviteit
SIGNATURE BY EOL

⁽³⁾ p. 700 mm : uniquement décor MG & RI en stock - D. 700 mm : only available on MG and RI from stock - 700 mm : allenn op voorraad voor MG en RI.

⁽⁴⁾ Le top est personnalisable uniquement pour la version standard (H. 735 mm) - The top is customizable for standard version only (H. 735 mm) - Topblad personaliseerbaar enkel voor de standaardversie (H. 735 mm)

2. METAL (accessoire) - METAL (accessories) - METAAL (accessories)

			STOCK (0)						DÉLAI (2)
SO Blanc lisse White Wit	SA Aluminium Aluminium Alugrijs	SC Gris anthracite structuré Textured graphite grey Gestructureerd antraciet				SD Gris clair Light grey Lichtgrijs	SU Gris souris structuré Textured mouse grey Gestructureerd muisgrijs	SG Noir Black Zwart	
						DÉLAI (2)			
X9 Vieux rose Dusty pink Oud roze	Z1 Rouge noir Red black Zwart rood	X8 Vert pâle Pale green Bleek groen	X7 Turquoise pastel Pastel turquoise Pastel turquoise	X5 Jaune tournesol Sunflower yellow Zonnebloem geel	X6 Rouge carmin Carmine red Karmijn rood				
					DÉLAI (2)				
Z2 Bleu Capri Capri blue Capri blauw	X4 Bleu cobalt Cobalt blue Kobalt blauw	X3 Vert émeraude Emerald green Smaragd groen	X2 Gris platine Platinum grey Platina grijs	Z3 Laiton Brass Messing					

+5%

Edition juillet 2019

SHOWROOMS

| PARIS

171, Avenue des Grésillons - 92230 Gennevilliers
Tel : +33 (0)1 47 33 47 37

| LONDON

4th Floor - 14-18 Old Street - London EC1V 9BH UK
Tel : +44 (0)203 794 66 07

| BRUXELLES

81, Chaussée de Nivelles - 1420 Braine-l'Alleud
Tel : +32 (0)2 894 99 80