

# Diamante

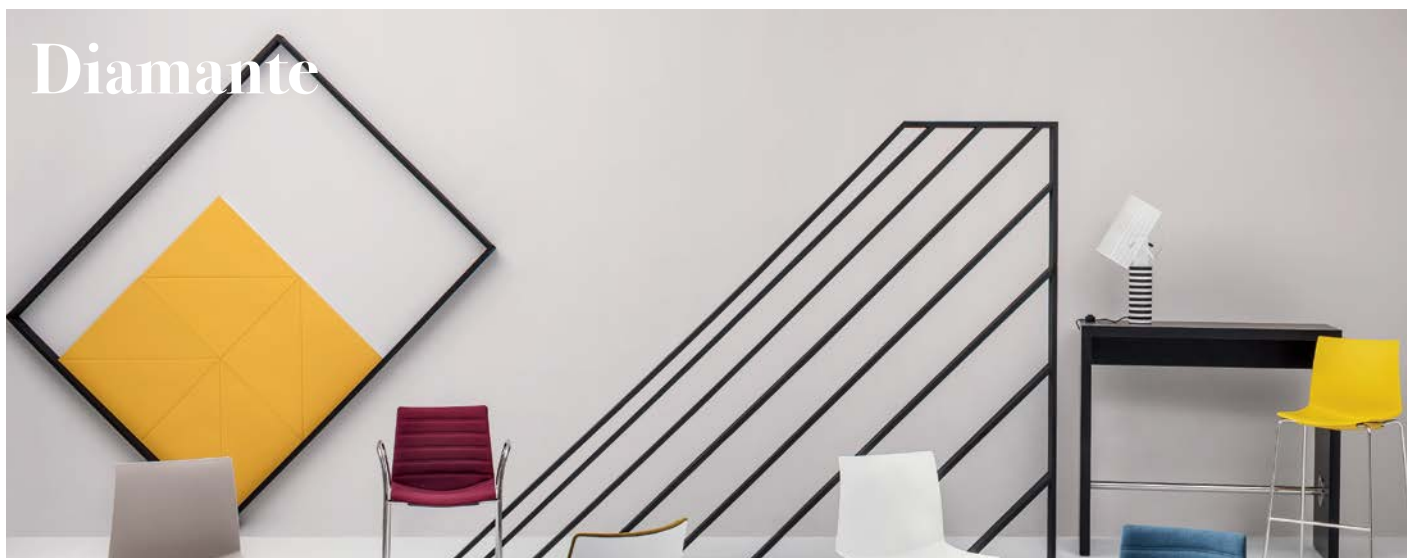

Collection certified UNI EN ISO 354:2003, sound absorption A Class following UNI EN ISO 11654:1998.  
 Collezione certificata UNI EN ISO 354:2003, Classe A di assorbimento acustico secondo la norma UNI EN ISO 11654: 1998.

## Diamante 4 / Diamante Double 4 / Diamante Spotlight X2 / X4 Coverings



## Frame colors

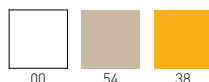

### DIAMANTE 4

Diamond sound-absorbing panels.  
 Pannelli fonoassorbenti Diamante.

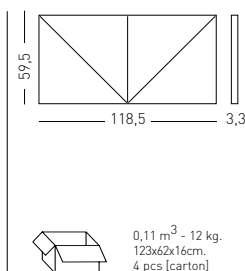

#### Finishing & Codes / Finiture e Codici

**cod.PADI4.\_.\_** Diamante 4 Coverings

Diamante 4 customized printed panel  
 Pannello Diamante 4 personalizzato stampato  
 (min 4pcs)

### DIAMANTE DOUBLE 4

Diamond sound-absorbing panels with double coverings.  
 Pannelli fonoassorbenti Diamante con doppia copertura.

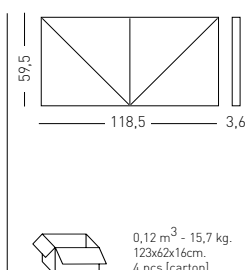

#### Finishing & Codes / Finiture e Codici

**cod.PADI4D.\_.\_** Diamante Double 4 Coverings

Diamante 4 Double customized printed panel  
 Pannello Diamante 4 Double personalizzato stampato (min 4pcs)

### DIAMANTE SPOTLIGHT X2

Sound-absorbing panel with integrated lighting kit (2 led).  
 Pannello fonoassorbente con kit illuminazione integrato (2 led).



Only with ACCV005 horizontal suspension kit.  
 Solo con ACCV005 kit sospensione orizzontale.

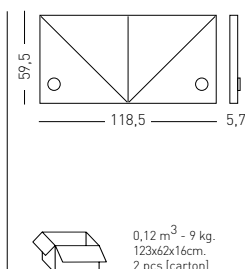

#### Finishing & Codes / Finiture e Codici

**cod.PADLX2.--**

## DIAMANTE SPOTLIGHT X4



Sound-absorbing panel with integrated lighting kit (4 led).  
Pannello fonoassorbente con kit illuminazione integrato (4 led).

Only with ACCV005 horizontal suspension kit.  
Solo con ACCV005 kit sospensione orizzontale.

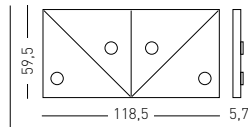

0,12 m<sup>3</sup> - 9 kg.  
123x62x16cm.  
2 pcs [carton]

Finishing & Codes / Finiture e Codici

**cod.PADLX4.--**

## DIAMANTE VERTICAL SUSPENSION

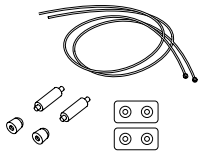

Vertical suspension optional kit, length 3m.  
Kit opzionale sospensione verticale, lunghezza 3m.

Codes / Codici

**ACCV004**

## DIAMANTE HORIZONTAL SUSPENSION

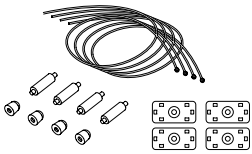

Horizontal suspension optional kit, length 3m.  
Kit opzionale sospensione orizzontale, lunghezza 3m.

Codes / Codici

**ACCV005**

## DIAMANTE PEDESTAL

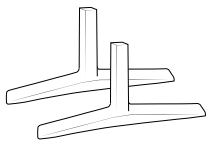

2 white legs pedestal optional kit.  
Kit opzionale 2 gambe piedistallo bianche.

Codes / Codici

**ACCV006.00 white/bianco**

## DIAMANTE PARTITION LEG



Screen partition optional kit.  
Kit opzionale divisorio.

Codes / Codici

**ACCV007**

## DIAMANTE WALL FIXING

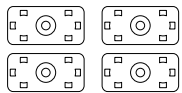

Wall fixing optional kit.  
Kit opzionale fissaggio a parete.

Codes / Codici

**ACCV008**

## DIAMANTE LIGHTING SYSTEM

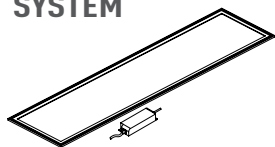

Horizontal suspension lighting system kit.  
Kit di illuminazione per sospensione orizzontale.

Codes / Codici

**ACCV009**



## DIAMANTE PARTITION A

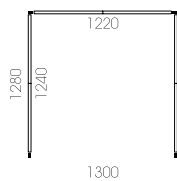

0,50 m<sup>3</sup> - 32 kg.  
1 pc [carton]

Finishing & Codes / Finiture e Codici

**cod.PAPADA.--**

## DIAMANTE PARTITION B

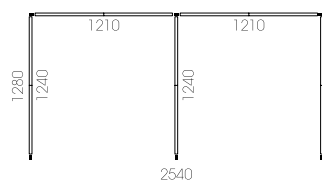

0,60 m<sup>3</sup> - 52 kg.  
1 pc [carton]

Finishing & Codes / Finiture e Codici

**cod.PAPADB.--**

## DIAMANTE PARTITION C

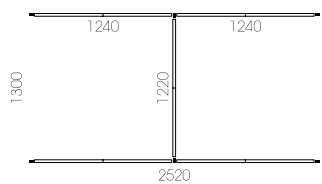

0,60 m<sup>3</sup> - 52 kg.  
1 pc [carton]

Finishing & Codes / Finiture e Codici

**cod.PAPADC.--**

## DIAMANTE PARTITION D

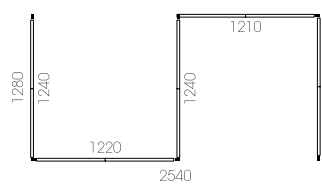

0,60 m<sup>3</sup> - 52 kg.  
1 pc [carton]

Finishing & Codes / Finiture e Codici

**cod.PAPADD.--**

## DIAMANTE PARTITION E

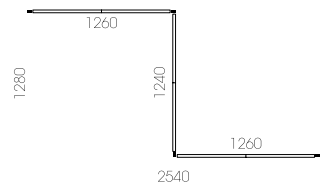

0,50 m<sup>3</sup> - 32 kg.  
1 pc [carton]

Finishing & Codes / Finiture e Codici

**cod.PAPADE.--**

## DIAMANTE PARTITION F

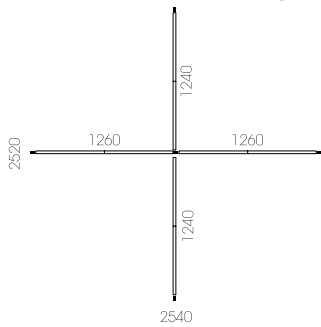

0,50 m<sup>3</sup> - 44 kg.  
1 pc [carton]

Finishing & Codes / Finiture e Codici

**cod.PAPADF.--**

## DIAMANTE PARTITION A2

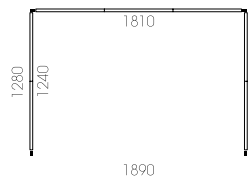

0,50 m<sup>3</sup> - 36 kg.  
1 pc [carton]

Finishing & Codes / Finiture e Codici

**cod.PAPADA2.--**

## DIAMANTE PARTITION B2

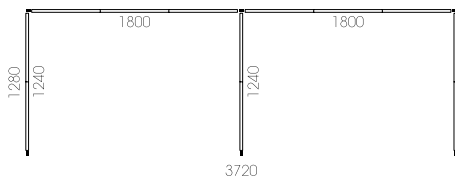

0,60 m<sup>3</sup> - 60 kg.  
1 pc [carton]

Finishing & Codes / Finiture e Codici

**cod.PAPAB2.--**

## DIAMANTE PARTITION C2

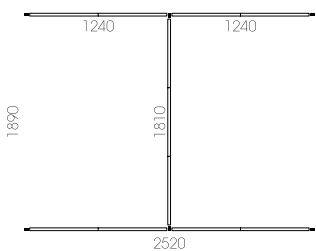

0,60 m<sup>3</sup> - 56 kg.  
1 pc [carton]

Finishing & Codes / Finiture e Codici

**cod.PAPADC2.--**

## DIAMANTE PARTITION D2

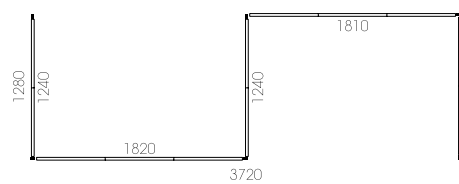

0,60 m<sup>3</sup> - 60 kg.  
1 pc [carton]

Finishing & Codes / Finiture e Codici

**cod.PAPADD2.--**